

Overview of the 2007 National Offshore Aquaculture Act

**Dr. Michael Rubino
Manager, NOAA Aquaculture Program**

**New England Fishery Management Council Meeting
April 10, 2007**

Aquaculture is a National Priority

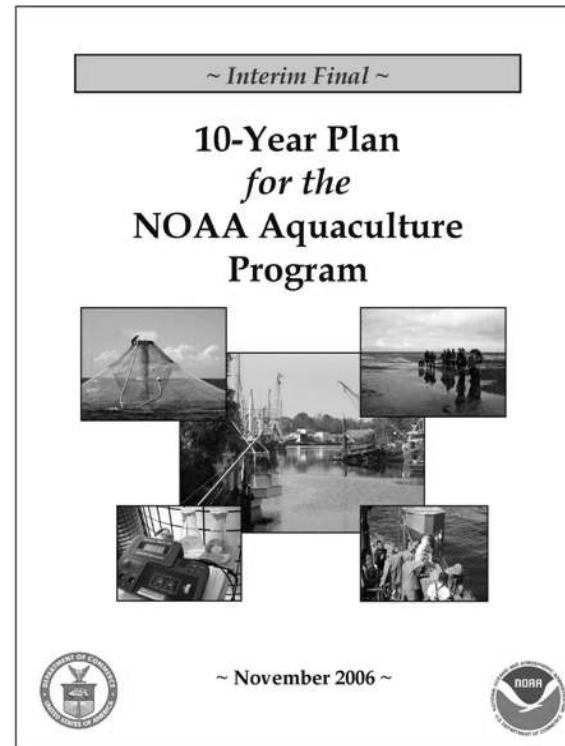
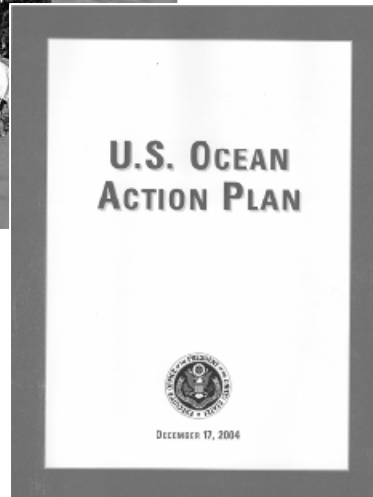
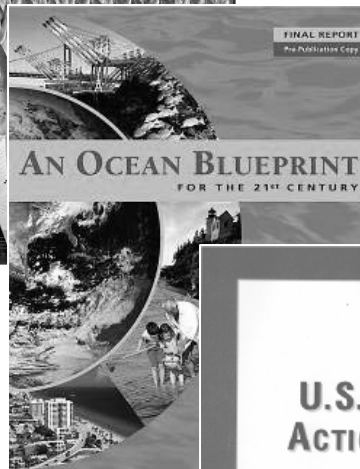

www.aquaculture.noaa.gov

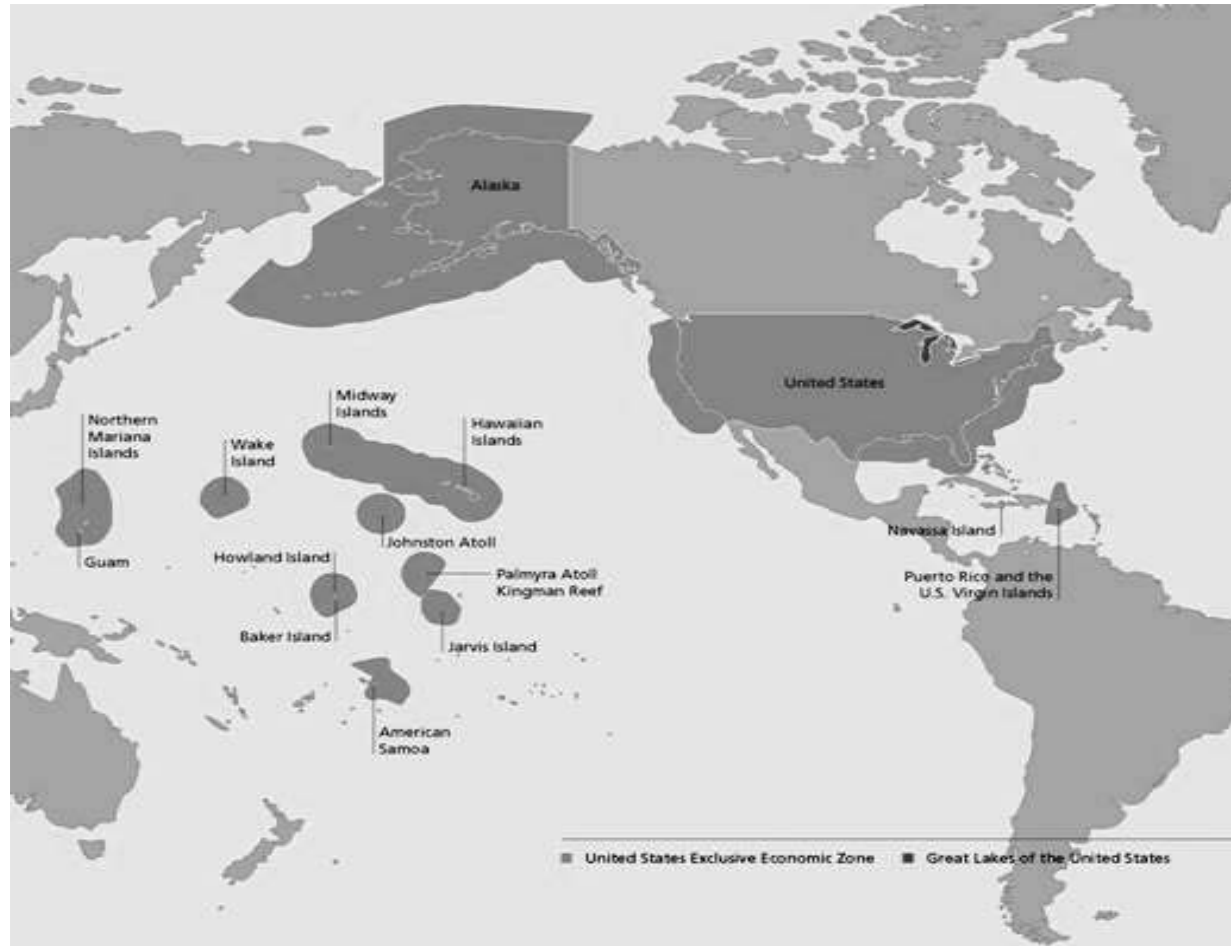

www.aquaculture.noaa.gov

Finfish Culture in Open Ocean Conditions in the U.S.



www.aquaculture.noaa.gov

Cage Design – Hawaii

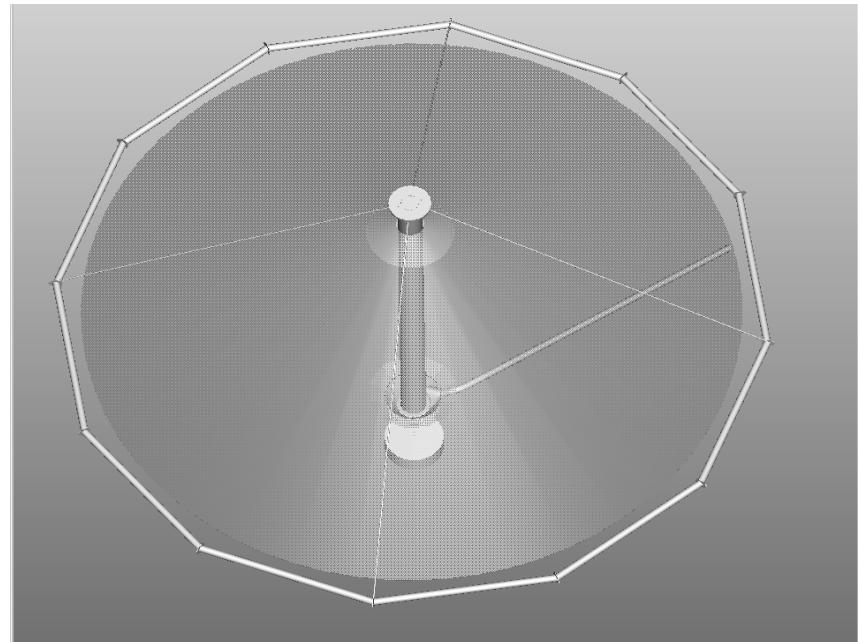
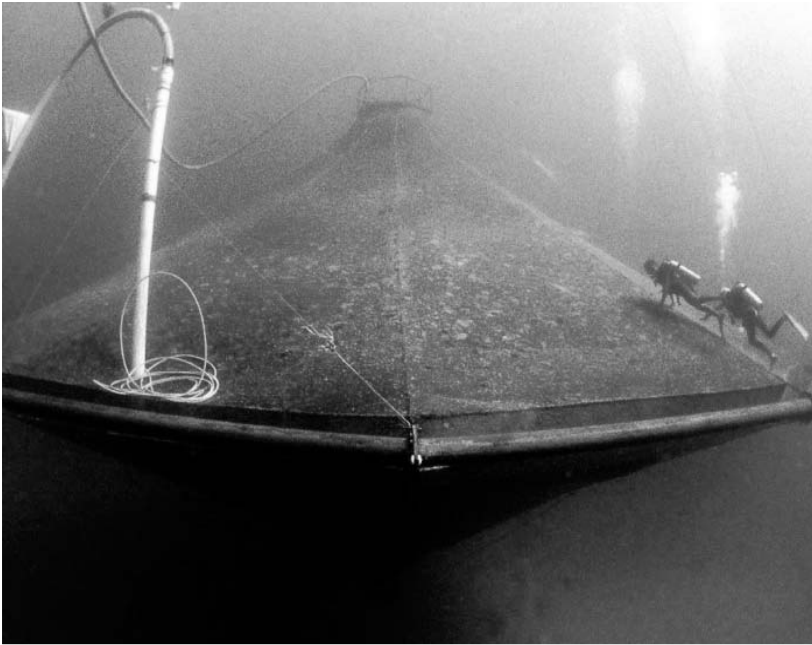

Open Ocean System

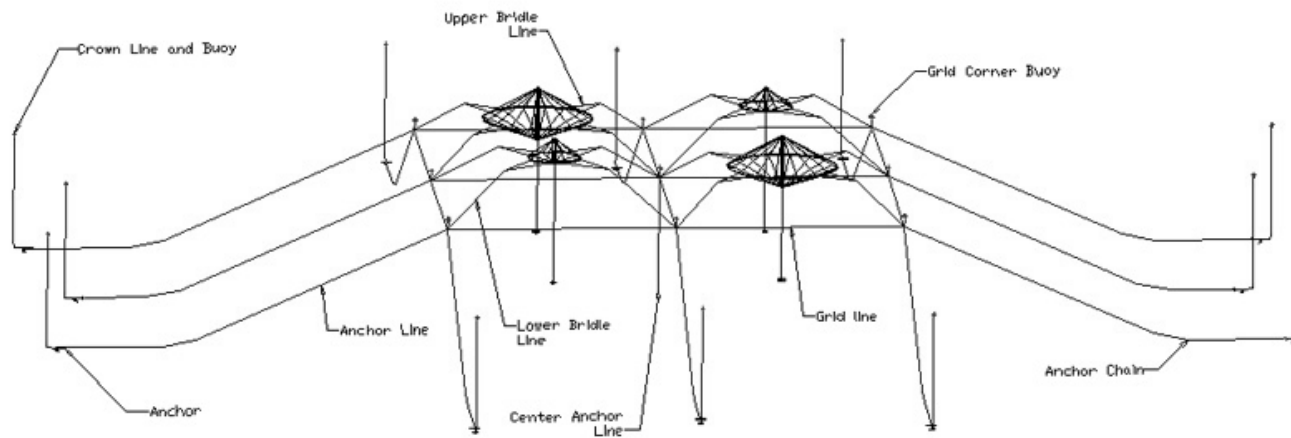

Open Ocean System – Hawaii



Cage Design – Puerto Rico



www.aquaculture.noaa.gov

Small Cage Design – University of New Hampshire



Ideas for Offshore Aquaculture Systems Abound



Japan



Sweden



Russia



Spain



Norway

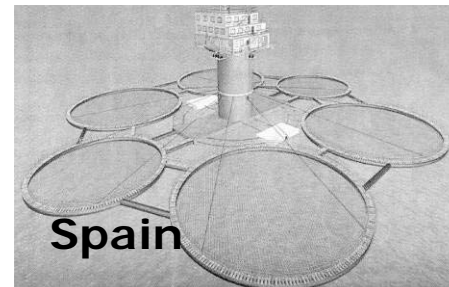

Spain

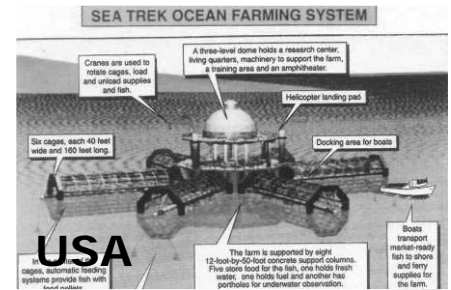

USA



USA

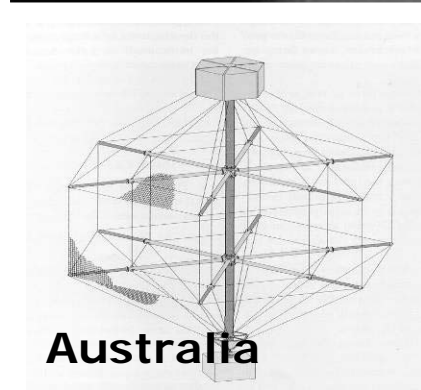

Australia

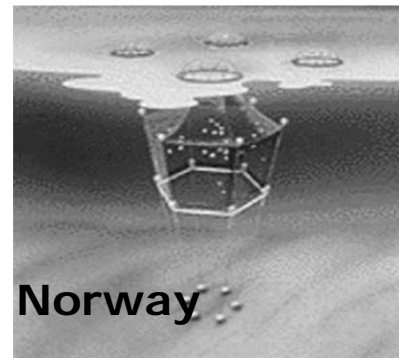

Norway

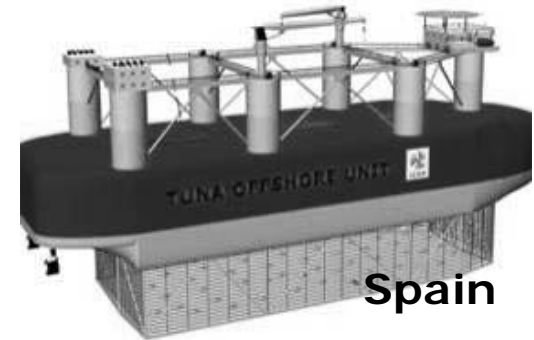

Spain

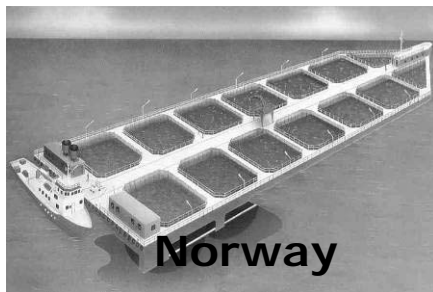

Norway

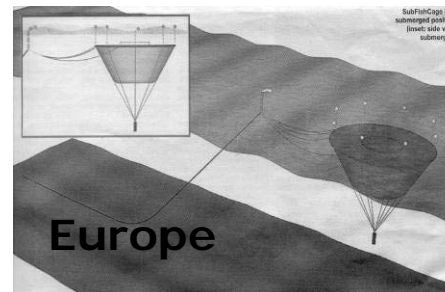

Europe

Open Ocean System – Gulf of Maine

New Hampshire Open Ocean Aquaculture Demonstration Site

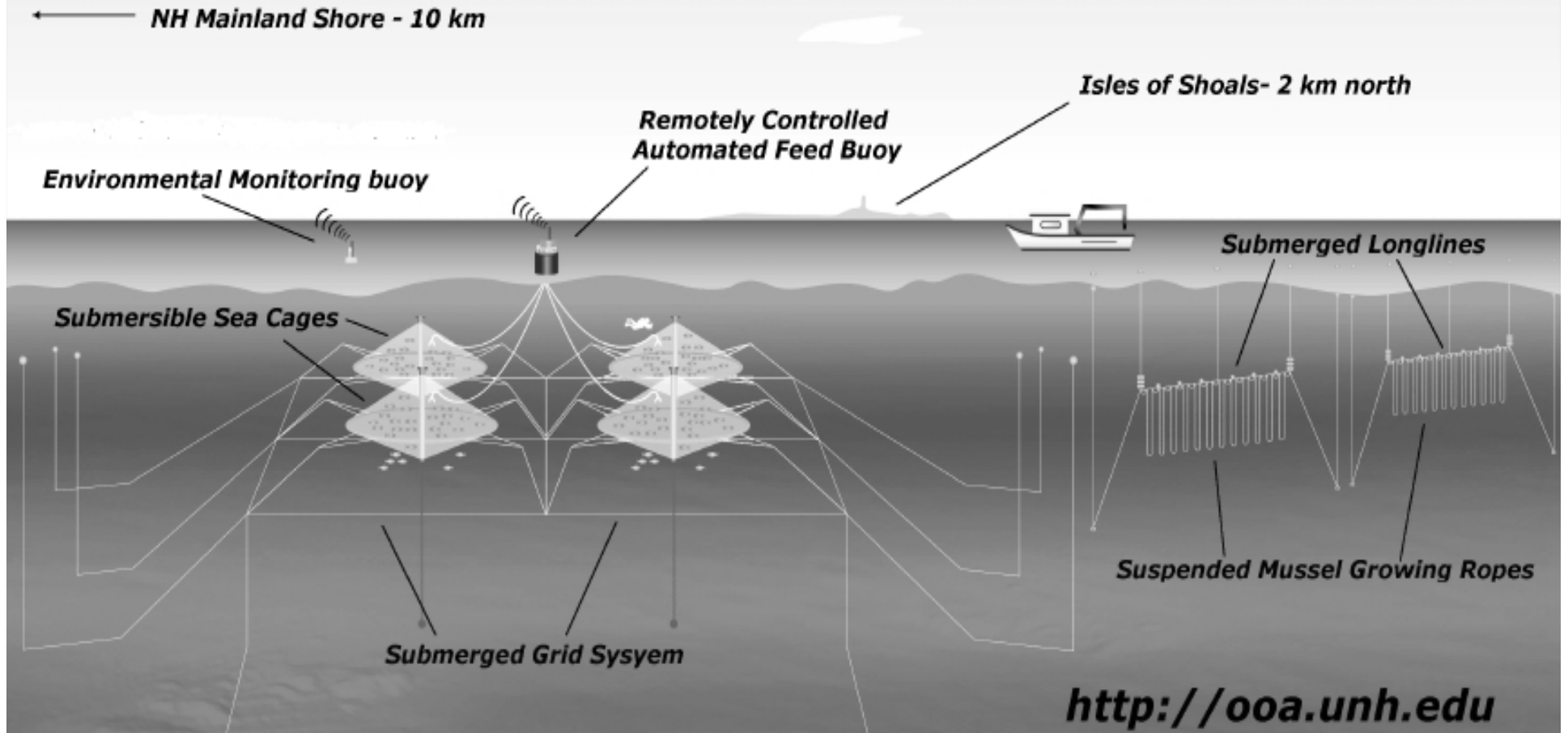

Mussel Culture in the Gulf of Maine

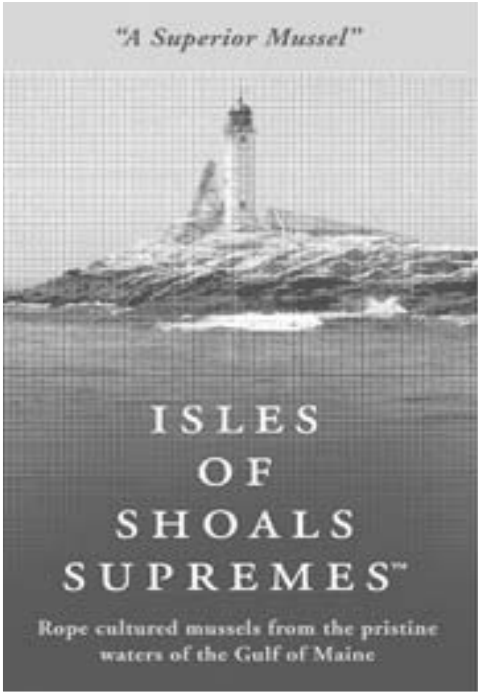

rope cultured mussels

Technology Development - Mussel Culture



www.aquaculture.noaa.gov

Technology Development Depends on Local Expertise



Technology Development - Remote Observation & Control

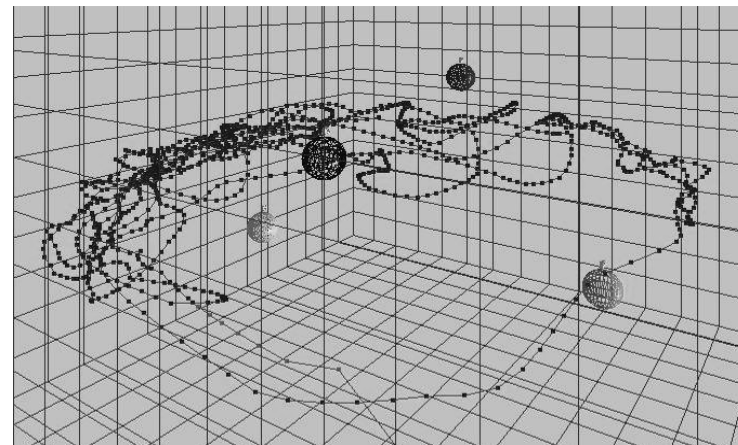

Technology Development - Automated Feeding Systems

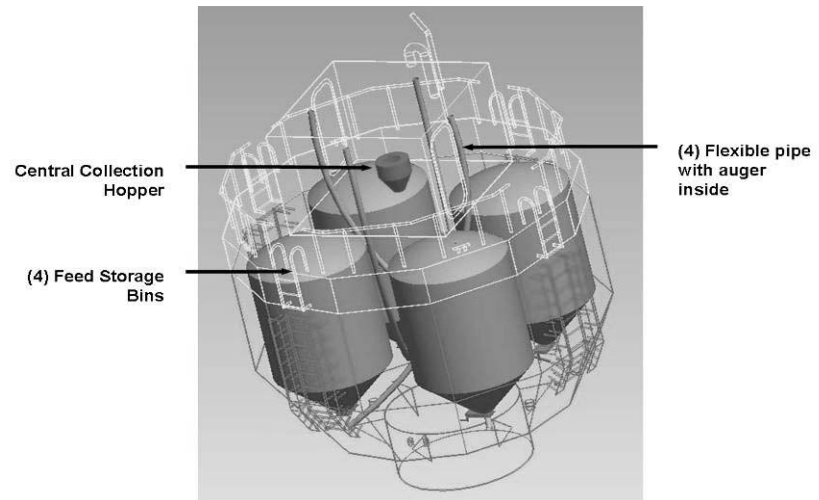
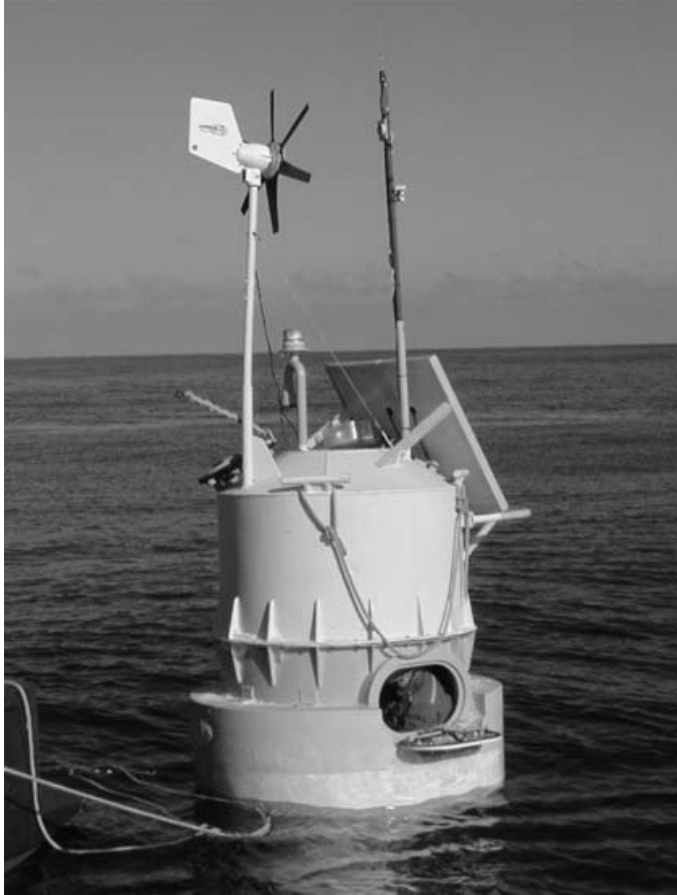

www.aquaculture.noaa.gov

U.S.-Produced Finfish & Shellfish

Atlantic Cod



Kona Kampachi



Pacific Threadfin



Mussels

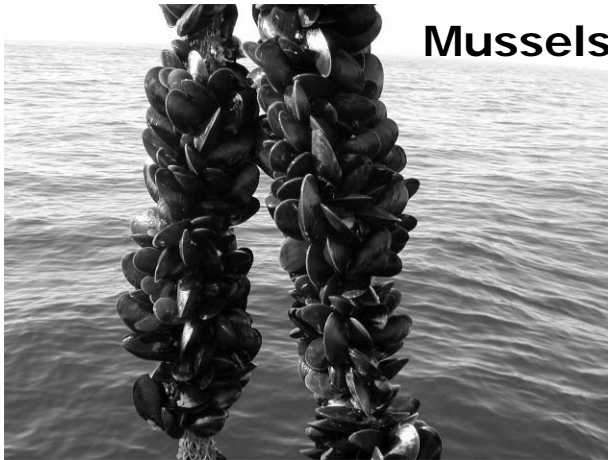

Cobia

